

Nexans LANactive XGigaSwitch DICE

User Manual

Version 1.0, November 2021



88306800 XGigaSwitch DICE 8TP 2SFP+ AC

88306801 XGigaSwitch DICE 8TP 2SFP+ DC

TABLE OF CONTENTS

Table of Contents.....	2
General Information	3
Safety Instructions.....	4
Product Labels	6
Product Features.....	7
Interfaces	10
LED Indicators	12
Mounting Options.....	14
Power Connection.....	17
Power over Ethernet	19
Grounding	21
Memory Cards and Console Cables	22
I/O Module	23
Start-up – Booting	24
ANS Support Portal.....	26
EC Declaration of Conformity.....	27
Accessories.....	28

GENERAL INFORMATION

Nexans Advanced Networking Solutions GmbH (ANS) as part of Nexans Telecom & Data Business Group is a market pioneer for Fibre To The Office (FTTO) systems. Nexans offers over 35 years of experience in research, development and production of FTTO and Industrial Ethernet switches. Customers include top global companies and institutions. Nexans guarantees exceptional product quality 'Made in Germany'. With an integrated concept including accessories and software features, Nexans offers end users and partners an extensive support program, tailor-made concepts and the ability of customization.

Purpose of the manual

This manual describes the features, functions, operation and commissioning of the following devices of the XGigaSwitch series:

- **88306800** **XGigaSwitch DICE 8TP 2SFP+ AC**
- **88306801** **XGigaSwitch DICE 8TP 2SFP+ DC**
- **88301666** **iOption PoE++ 6/8P-90W**
- **88301604** **iOption PoE+ 6/8P-30W**

Target group

This document is designed for planners and installers of enterprise network solutions, electrical engineers, persons entrusted with setting, testing and maintaining office switches.

Scope of the manual

This manual is valid for the Nexans XGigaSwitch series in combination with the current version of the Nexans Device Manager, **LANactive Manager Version 7.02**.

The User Manual may include more than one product. Part of the content, e.g. some use cases or specifications, may only apply to some of them. For more information on the exact feature set and specifications, see the product's web page and datasheet.

Support

The latest version of the firmware and the management tool can be downloaded at the Nexans Support Portal: <https://www.nexans-ans.de/support/>. There are also all related release notes and the current versions of software manual available.

For any questions or problems, please contact the following support e-mail address: support.ans@nexans.com

To benefit from individualized and extended product support, Nexans recommend to conclude a Nexans support contract. To get more information, please contact Nexans via e-mail: sales.ans@nexans.com

Disclaimer

The content of this manual has been checked for compliance with the hardware and software described. Nevertheless, deviations cannot be ruled out, so no liability is assumed for the complete agreement. The information in this manual is reviewed regularly and any necessary corrections are included in subsequent editions. Suggestions for improvement are welcomed. Technical changes are reserved, even without notice.

SAFETY INSTRUCTIONS

Safety instructions

Only qualified personnel may install and commission the XGigaSwitch. Country-specific regulations must be observed.

- It is only allowed to install the device in a dry and dust-free environment.
- Avoid direct solar irradiation to the device and ensure sufficient ventilation.
- Liquids must not enter the device.
- Do not open the device. There is the risk of electric shock.



ATTENTION: Electrical damage

For device protection, connect a thermomagnetic fuse.



CAUTION: Danger due to electric shock!

Never work with applied voltage.

Maintenance and Repair

The switches are maintenance-free devices. Repairs are only permitted by the manufacturer or by persons authorized by the manufacturer. In case of doubt, please contact the manufacturer.

Cleaning

The switch can be cleaned using a cloth which has been dampened with a mild cleaning agent. Please take care that no cleaning agent enters the interior of the unit.

Waste Management

After use, the switch and all electronic parts contained in the scope of delivery must be disposed of properly according to legal law at a responsible collection point.



Accessories

Only original accessories may be used. Any other accessories are only allowed if they do not impair the safety of the device.

Packaging

Do not throw away the packaging. The packaging has been designed for repeated use if not damaged during transport. Only the original packaging can reliably protect the unit from damage during later transport.

Checking the scope of delivery

After receiving the product, the scope of delivery should be checked. A detailed list of the scope of delivery is shown in chapter Technical Data on page 8.

Checking for transport damage

Please check the unit for transport damage after unpacking. Transport damage can be assumed in particular if the packaging is visibly damaged. Do not try to operate an obviously damaged unit. This may result in further consequential damages.

Recovery after storage and transport

Moisture can condensate on the unit if the unit has been stored or transported at low temperatures and subsequently taken into a warm room. To avoid any damage please wait till any moisture condensation has vanished from the unit's surface before switching the unit on. The unit is operational only after it has reached the guaranteed operating temperature range (see Technical Data on page 8). The same applies also to prior storage at high temperatures.

PRODUCT LABELS

The Nexans LANactive XGigaSwitch DICE is equipped with product labels for the purposes of quality assurance and documentation. The product labels contain unique device-specific information that can be used for project documentation. This information includes MAC address and serial number. The two numbers are unique and refer to each individual device.

The information about the respective MAC address is located twice on the switch. Once on the bottom side of the device and a second at the front. The sticker at the front can also be read when the XGigaSwitch is installed.

Use the barcodes of the product label with the MAC address and serial number information to simply read in the device lists using commercially available scanners and document them in tabular form. Associate the MAC address with the information about the installation location and the switch description.



Figure 1: Product label



Figure 2: MAC-Address label at the front

PRODUCT FEATURES

LANactive 10G/MultiGigabit Ethernet Managed Switch

- 2 Uplink Ports (SFP+) and 8 Access Ports (RJ45)
- Power over Ethernet (PoE++) up to 90Watts per port (optionally)
- Energy Efficient Ethernet
- Memory Card Slot
- Wide Input Voltage Range: 46 ... 57V DC or 90 ... 264V AC

Description

Nexans LANactive XGigaSwitch is optimized for supporting Wireless LAN infrastructures. Based on MultiGigabit copper and 10 Gigabit SFP+ interfaces the switch is able to support the bandwidth required by the latest Wireless LAN standards.

Access Ports

The XGigaSwitch has 8 Access Ports connecting Wireless LAN Access Points, IP Cameras, Connected Lighting or Smart Building Systems. Four Access Ports supporting MultiGigabit to avoid any bottleneck with the latest WLAN technology standards.

Ceiling Installation

A very compact design allows a smart ceiling installation. In combination with the fan less design the operation without noise is guaranteed. A separated power supply allows a flexible support of all power budgets.

Power over Ethernet

The latest Power over Ethernet standard IEEE802.3bt enables the remote powering with up to 90W per port. Equipment like Wireless LAN Access Points, IP-Cameras, Connected Lighting or Smart Building Systems can be supplied with power from the switch directly. The Power over Ethernet functionality can be parameterized, controlled and monitored via management.

Memory Card

The optional memory card automatically saves the complete current configuration and firmware of the device. In case of failure, this feature allows an easy exchange of the hardware without additional configuration. In addition, each memory card can be delivered with its own MAC address that is adopted by the switch.

Switch Management and Zero-Touch Configuration

LANactive Manager allows a simple and secure configuration of all device parameter of the XGigaSwitch series. With LANactive Manager a larger number of XGigaSwitches can be managed and monitored at the same time. In combination with Nexans Zero-Touch Configuration, the LANactive Manager allows automatic distribution of configurations and firmware updates. A pre-configuration of the switches is not necessary.

Technical Data

The following table contains the basic technical data and the differences in the available versions. A detailed technical overview can be found in the corresponding datasheet of the products.

	XGigaSwitch DICE 8TP 2SFP+ AC	XGigaSwitch DICE 8TP 2SFP+ DC
Article Number	88306800	88306801
Uplink Ports	2x SFP+ with 1/10 Gbps	
User Ports	4x 2.5GBase-T and 4x 1000Base-T	
PoE Options	8x PoE+ or 8x PoE++ via option, see table below	
Memory Card Slot	Yes, SD-Card	
Dimensions (B x H x D)	345 x 53 x 170 mm	
Weight	1,900g	1,500g
Operating Temperature	0...45°C	
Input Voltage Range	90...264V AC	46...57V DC
Power Connector	C14 connector (L, N, PE)	3-pin connector with plug-in screw terminal (up to 2.5mm ²) / (+) (-) (FG)
Scope of Delivery	Power cable, 1,5m with Power Connector (CEE 7/4)	3-Pin Power Connector
	4x stick-on pads	4x stick-on pads
	Documentation	Documentation
	iOption PoE+ 6/8P-30W	iOption PoE++ 6/8P-90W
iOption*		
Article Number	88301604	88301666
According to	IEEE802.3at, PoE+	IEEE802.3bt, PoE++
Number of PoE Ports	8x PSE(PoE+) acc. to IEEE802.3at	8x PSE(PoE++) acc. to IEEE802.3bt, Type 3&4
PoE Mode	30W per Port, Mode A, Pin 1-2/3-6	Up to 90W per Port, 4-Pair 1-2/3-6/4-5/7-8

* iOptions are optionally and must be ordered separately. If an iOption has been ordered, it is mounted and integrated during production process. An integration later in the field is not possible.

Dimensions



Figure 3: XGigaSwitch dimensions

INTERFACES

XGigaSwitch DICE 8TP 2SFP+ AC

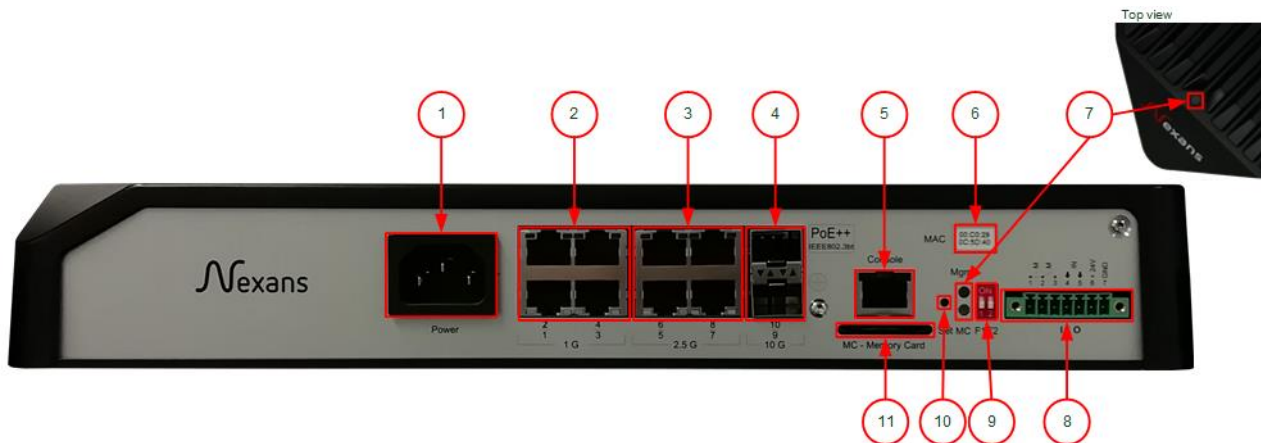

Figure 4: Interfaces of XGigaSwitch DICE 8TP 2SFP+ AC

1. 230V AC Power Connector (Type: C14) 90...264V AC ~50/60Hz, 6.5A(115V), 3.0A (230V)
2. RJ45 Port 1-4: 1000Base-T (1000/100/10 Mbps)
3. RJ45 Port 5-8: 2.5GBase-T (2500/1000/100 Mbps)
4. Port 9-10: SFP+ (1/10 Gbps)
5. Console port (RJ45)
6. MAC-Address label
7. Status LEDs (Mgmt. on front and top)
8. I/O Interface
9. DIP switches
10. SET Button
11. Memory Card slot (Format: SD)

XGigaSwitch DICE 8TP 2SFP+ DC

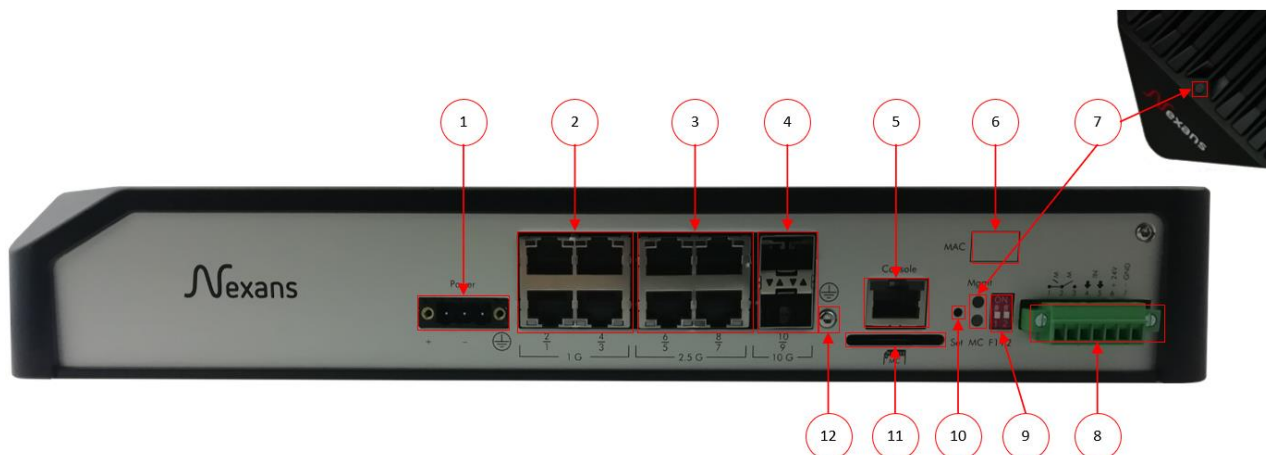







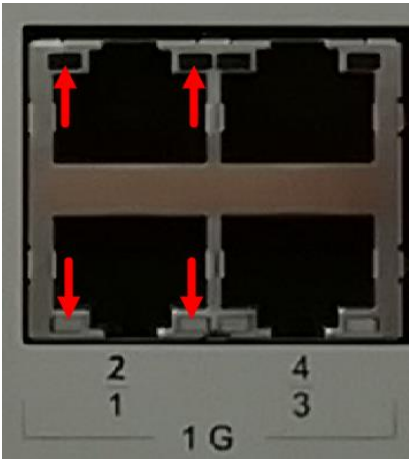







Figure 5: Interfaces of XGigaSwitch DICE 8TP 2SFP+ DC

1. 54V DC Power Connector , see chapter: Power Connection on page 17
2. RJ45 Port 1-4: 1000Base-T (1000/100/10 Mbps)
3. RJ45 Port 5-8: 2.5GBase-T (2500/1000/100 Mbps)
4. Port 9-10: SFP+ (1/10 Gbps)
5. Console port (RJ45)
6. MAC-Address label
7. Status LEDs (Mgmt. on front and top)
8. I/O Interface
9. DIP switches
10. SET Button
11. Memory Card slot (Format: SD)
12. Grounding Screw

LED INDICATORS

The following table shows the LED status.

	Management LED (Mgmt)		
		Blue on	Switch is booting
		Blue flashing	Loading firmware
		Green flashing	DHCP running
		Green on	Switch up dynamic IP address
		Red on	Switch started with fixed IP address
	Memory Card LED (MC)		
		On	SD card detected
		Off	No SD card detected
		TP Links (left side)	
		Off	No link detected
		Green on	Link detected
		Green flashing	Data traffic detected
PoE Status (right side)			
		Off	PoE disabled
		Yellow on	PoE enabled

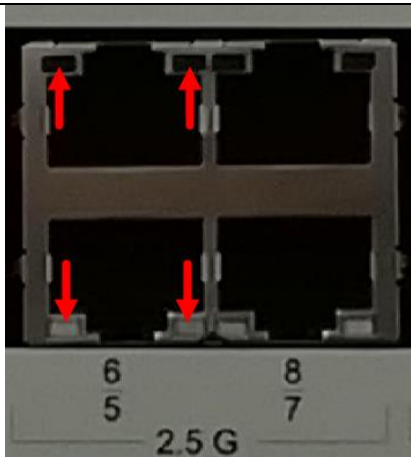

TP Links

	Off	No link detected
	Green on	Link detected
	Green flashing	Data traffic detected

PoE Status

	Off	PoE disabled
	Yellow on	PoE enabled

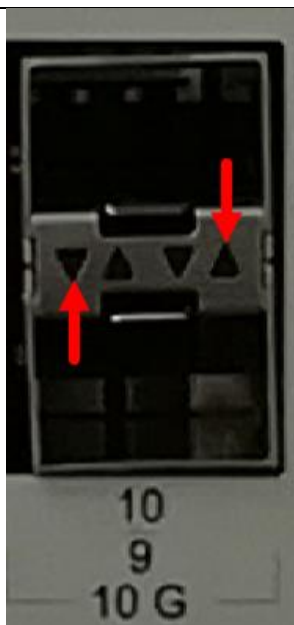

SFP+ Links

	Off	No link detected
	Green on	Link detected
	Green flashing	Data traffic detected

MOUNTING OPTIONS

The XGigaSwitch DICE can be physically installed in various ways. It can be used as a desktop device or in combination with different types of mounting kits.

Desktop Usage

The easiest way to use the XGigaSwitch DICE is the usage as a desktop device. The scope of delivery contains four pads to stick-on the bottom side of the switch.

On-wall Installation with Hook-On Mechanism

For an on-wall installation different mounting kits are available.

With the basic mounting plate (part number 88646400) the XGigaSwitch DICE can be mounted on the wall toolless.

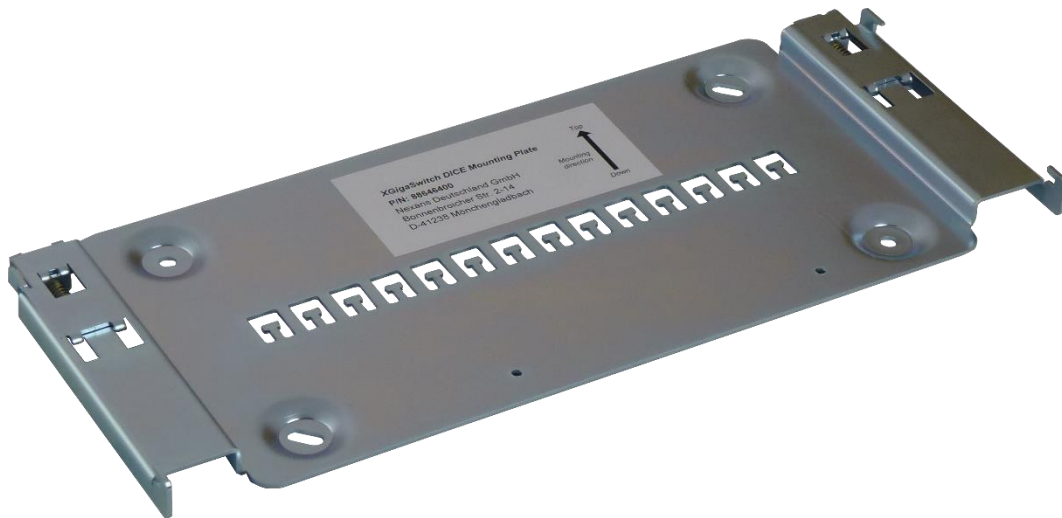

Figure 6: Mounting Plate

An additional strain-relief (part number: 88646401) can be fix to the mounting plate.



Figure 7: Strain-relief

The strain-relief is fixed to the mounting plate with the attached screws.

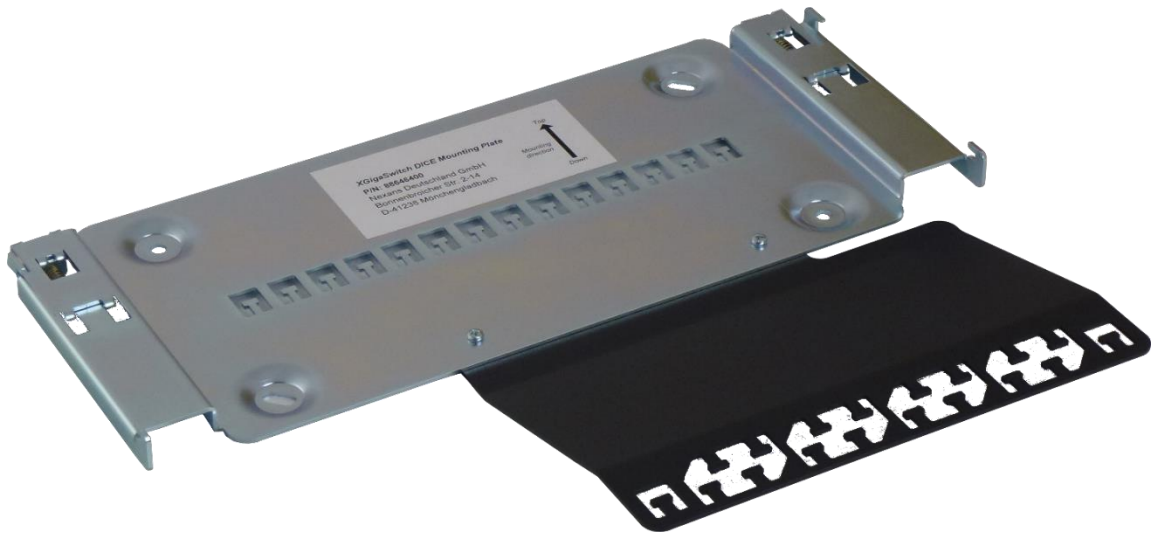

Figure 8: Mounting Plate with additional strain-relief



Figure 9: Mounting Plate with strain-relief and DICE

The XGigaSwitch DICE is mounted via a so-called hook-on mechanism to the mounting plate. Detailed information regarding the installation are written in a separate document.

19" Installation

To install the LANactive XGigaSwitch DICE in a 19" rack the following adaptors are available (part number: 88646402).



Figure 10: 19" Mounting Kit

The adaptors are mounted with the attached screws on the bottom side of the XGigaSwitch DICE.

DIN-Rail Installation

For a DIN-Rail installation a separate DIN-Rail mounting clip (part number: 88306811) can be used. The mounting clip can be fix at the bottom side of the switch. For the mounting only the attached screws must be used.



Figure 11: XGigaSwitch with DIN-Rail clip

POWER CONNECTION

The XGigaSwitch DICE **AC** version has an integrated power supply and may be connected to a 110/230V AC circuit. Therefore, the enclosed power cord should be used.

Pin Assignment for 54V DC connection

The XGigaSwitch DICE **DC** version has no integrated power supply and must be connected to a 54V DC power source. It is recommended to use the power supply unit offered by Nexans (see chapter External Power Supply on page 18 Fehler! Textmarke nicht definiert.).

In case another power source is used e.g. a central power supply, the enclosed 3-pin connector may be used to connect the XGigaSwitch to the DC power source. The following table shows the pin assignment and technical parameter to connect the 3-pin connector.





Input DC	Diameter [mm ²]	Diameter[mm ²]	AWG	Length [mm]	Torque [Nm]
					
FG / - / +	0.75 ... 2.5	0.75 ... 2.5	19 ... 12	8	0.6 ... 0.8



Figure 12: Pin assignment of 54V DC power connector

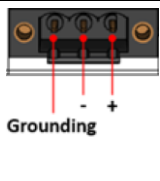

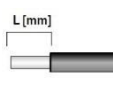
In any case please check the correct pin assignment and the correct polarity of the wiring at the supply unit.

External Power Supply



Figure 13: Desktop PSU 88646283

Ordering Information	Desktop Power Supply 54VDC/240W
Article Number	88646283
Output Power	240W
Connector Primary	C14
Connector Secondary	3-pin plug-in terminal
Dimension (L x W x H)	187 x 87 x 39 mm

POWER OVER ETHERNET

Power over Ethernet is an attractive and standardized alternative for the power supply of LAN equipment such as VoIP phones, Wireless LAN Access Points, IP video cameras etc., while using the "normal" Ethernet standard cable, i.e. without any additional cable tangle.

Function

An power source equipment (PSE) ensures the power supply of a powered device (PD). Nexans LANactive XGigaSwitch DICE series supports all three different PoE standards.

- PoE IEEE802.3af
- PoE+ IEEE802.3at
- PoE++ IEEE802.3bt

For Poe and PoE+, the standard defines 3 modes of operation for power supply, which is ensured via different wire pairings of the TP data connection:

- Endpoint PSE mode A - power supply via TP pairs 1/2 and 3/6
- Endpoint PSE mode B - power supply via TP pairs 4/5 and 7/8
- Midspan PSE mode B - power supply through an external device via TP pairs 4/5 and 7/8

PoE++ is using all four pairs (1/2, 3/6, 4/5, 7/8) for power transmission. However, PoE++ is backward compatible, that means PoE or PoE+ PDs can be connected and powered.

The PoE solution will only supply power if an appropriate powered device (PD) is detected. The following functions are checked prior to enabling PoE power supply:

- The active PSE source identifies the powered device (PD).
- The operational mode is detected.
- The required power class is detected based on the classification current.

Thus, any damages can be avoided, if the connected terminal unit is not standard-compliant.



In any case please check the correct pin assignment and the correct polarity of the PoE wiring at the terminal unit.

Mode A—Pairs 1/2 and 3/6

Power Source Equipment (PSE)		Powered Device (PD)	
MDI(X)		MDI	
1 BI_DB+	PoE-	PoE+	1 BI_DA+
2 BI_DB-	PoE-	PoE+	2 BI_DA-
3 BI_DA+	PoE+	PoE-	3 BI_DB+
4 BI_DD+			4 BI_DC+
5 BI_DD-			5 BI_DC-
6 BI_DA-	PoE+	PoE-	6 BI_DB-
7 BI_DC+			7 BI_DD+
8 BI_DC-			8 BI_DD-

Power Source Equipment (PSE+)

Thanks to the optional Power over Ethernet functionality, PoE-capable end devices can be supplied with power in accordance with corresponding IEEE 802.3 standard directly from the switch. The Power over Ethernet functions can be parameterized, controlled and monitored via management.

PoE class	Max. output power at PSE	Available power at PD	Classification signature	PoE standard
0	15.4 W	0.44 - 12.96 W	0 - 4 mA	IEEE 802.3af/at
1	4 W	0,44 - 3.84 W	9 - 12 mA	IEEE 802.3af/at
2	7 W	3.84 - 6.49 W	17 - 20 mA	IEEE 802.3af/at
3	15.4 W	6.49 - 12.95 W	26 - 30 mA	IEEE 802.3af/at
4	30 W	12.95 - 25.50 W	35 - 45 mA	IEEE 802.3at
5	45W	25.5 - 40W	36 - 44mA/1 - 4mA	IEEE 802.3bt
6	60W	40 - 51W	36 - 44mA/9 - 12mA	IEEE 802.3bt
7	75W	51 - 62W	36 - 44mA/17 - 20mA	IEEE 802.3bt
8	90W	62 - 71.3W	36 - 44mA/26 - 30mA	IEEE 802.3bt

Permitted voltage levels

The voltage ranges for the supply of switches are defined as follows:

PoE standard	Max. output power per port	Specified voltage range at the Power Source Equipment (PSE)	Voltage level at the switch, min. / typ. / max.
IEEE 802.3af (Type 1)	15.4W	44 - 57V DC	46 / 48 / 57V DC
IEEE 802.3at (Type 2)	30W	50 - 57V DC	50 / 54 / 57V DC
IEEE 802.3bt (Type 3)	60W	50 - 57V DC	50 / 54 / 57V DC
IEEE 802.3bt (Type 4)	90W	52 - 57V DC	50 / 54 / 57V DC



Please check compatibility, proper pin assignment and polarity prior to and during putting the system into operation to avoid any damage resulting from attaching incompatible equipment.

The maximum load of the individual ports and the overall load are limited. These limits have to be observed in any case. Otherwise the connected units might be damaged or cannot be operated (see Technical Data).

GROUNDING

XGigaSwitch for DC connection

To prevent unwanted interference and failures, the correct grounding of the XGigaSwitch DICE is very important. This becomes much more important if Power over Ethernet (PoE) is used and multiple powered (PD) devices are connected to the switch.

Nexans confirms that all LANactive switches are developed and manufactured according to the requirements of the PoE standards as defined by the Institute of Electrical and Electronics Engineers (IEEE) IEEE802.3af, IEEE802.3at and IEEE802.3bt.

In case of a centralized power supply that powers multiple switches and thus multiple PoE devices, the grounding must be connected next to the central power supply. In this case the **plus** voltage must be grounded by connecting it to the potential equalization of the building. The following figure shows the schematic of grounding the plus voltage.

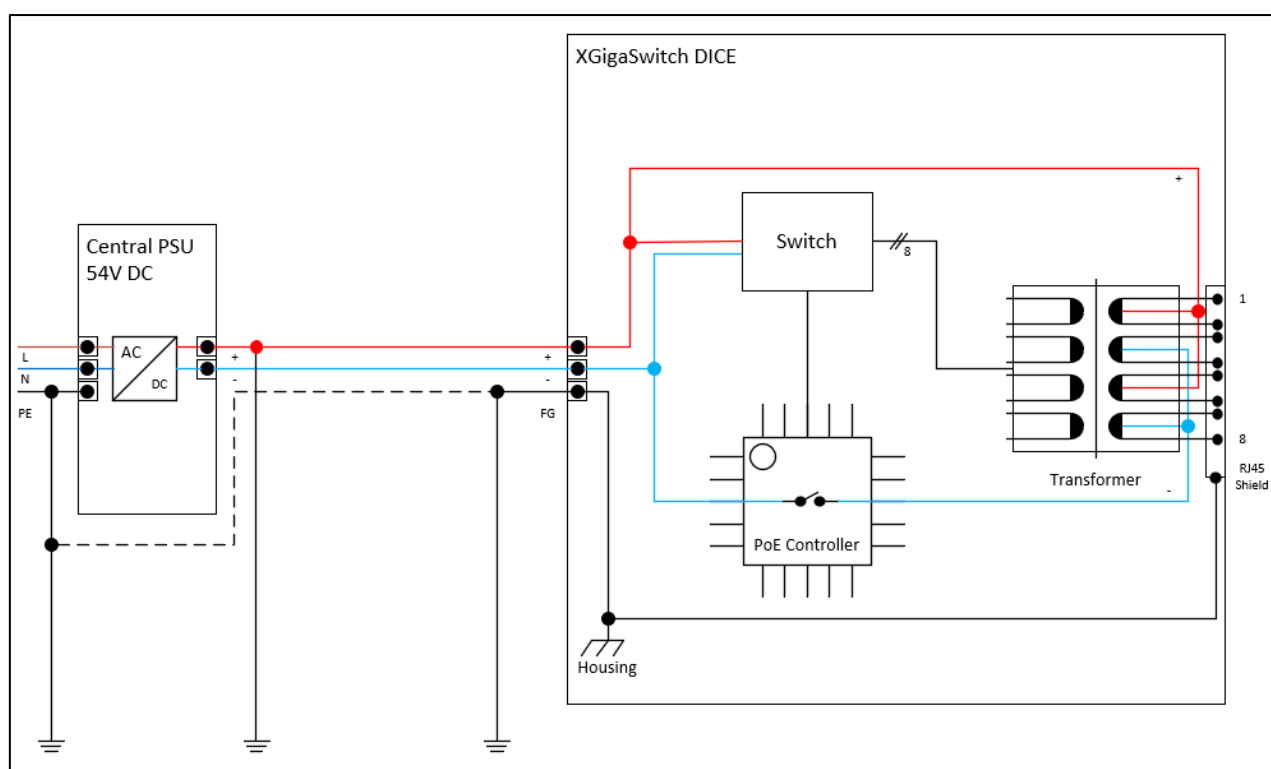

Figure 14: Block diagram of grounding

The switch can be grounded locally with the grounding terminal of the housing or connected to the central grounding by using a three-wired cable (+, -, Ground).



Never use the minus pol for grounding! In case of a wrong grounding at the connected client the risk of a short circuit is given.

MEMORY CARDS AND CONSOLE CABLES

Memory cards for switches

Nexans memory cards are redundant encrypted storage (AES256) for all types of LANactive switches which always stores its complete and most actual configuration and firmware automatically.

To make network maintenance processes easier, Nexans memory cards have unique MAC address fixed on it. Switch replaces its own MAC address with the one read from memory card. In case of a switch replacement the SD card needs to be removed from one switch and installed into the new one. The MAC-address, configuration and firmware will be taken on by the new switch from this SD-card. So, no changes in the network policy or pre-setup works need to be made as the system will see same switch as before.

Ordering Information	SD Memory Card with MAC-Address	SD Memory Card with MAC-Address plugged
Article Number	88300692	88300696
Delivery	Separately in plastic case	Pre-installed in the switch

Console configuration cables

The V.24 console port on Nexans switches allows you to configure the switch on site and/or retrieve its status without an Ethernet network connection. Configuration via the V.24 console port provides the same functionality as configuration via Telnet or SSH.

Ordering Information	RJ45 to USB adapter for serial console
Article Number	88300716
Connector A	RJ45
Connector B	USB



Figure 15: RJ45 console cable

I/O MODULE

The Nexans XGigaSwitch supports I/O ports on the front side of the device. The output, digital inputs and 24V DC output are electrically isolated against each other. The status and fault diagnostics of the I/O ports are monitored in the switch management.

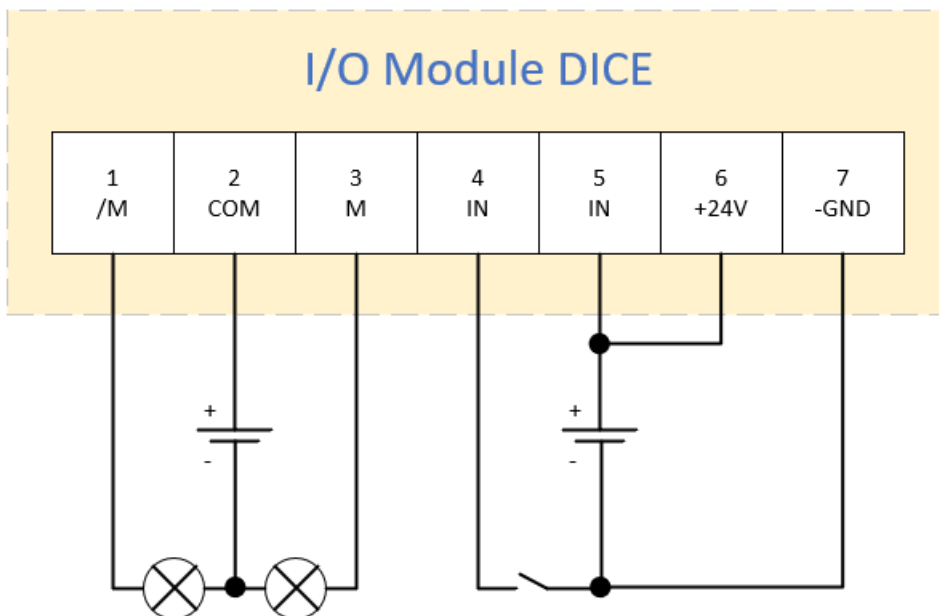

Figure 16: Connection plan of the I/O ports

The I/O module has one relays with two contact outputs, which by default have two functions - open and closed. This allows switching of the two digital channels. The relay output can switch two relay contacts. One contact is normally open and one normally closed. The relay contact outputs are controlled via user-configurable setpoints through switch management. The setpoints, operating parameters and interaction can be set in the "Industrial Alarms" menu of the switch management.

Pin	Signal
1	Relay contact normally closed contact
2	Relay common pin
3	Relay contact normally opened contact

The digital inputs are designed to receive 12-60VDC signals polarity with a max. input current of 1.5mA per input. The states of the input contacts is shown in the management.

Pin	Signal
4	Digital input contact 1
5	Digital input contact 2
6	Auxiliary voltage output power +24VDC, max. 40mA
7	Auxiliary voltage output power - (GND)

The output can be used as an auxiliary voltage to power the digital input without the need of an external power source.

START-UP – BOOTING

Nexans LANactive XGigaSwitch DICE can be operate in different modes called 'Operation Mode'. The following chapter explain the differences and how to switch between the different modes. If nothing is changed the switch boots with the default configuration stored in flash and DHCP for dynamic IP address assignment.

Operation Mode

The 'Set Button' (see Figure 4 no. 10) is used for selecting the following operating modes:

- Booting with flash configuration (default mode)
- Booting with fixed IP address
- Booting with factory default settings
- Booting with factory default settings and fixed IP address (optional)

IMPORTANT NOTE: The boot functions 'Booting with fixed IP Address' and 'Booting with Factory Default Settings' can be individually disabled via the management feature to prevent an accidental or deliberate manipulation by the user.

After disabling the switch "Boot with factory default settings", a reset of the switch to factory default settings is only possible via management access.

1. Hold configuration button >3 sec.

By pressing and holding the pushbutton (min. 3 seconds) the switch will change into the configuration mode, which is indicated by the Mgmt-LED going out. As soon as the Mgmt-LED is permanently off, the pushbutton must be released. A rapidly flashing blue Mgmt-LED shows that function number 1 has been selected.

2. Briefly press configuration button

By briefly pressing the pushbutton (min. 0.1 second) the desired function can now be selected, which is indicated via the respective LED colour:

Colour	Status
Blue	Booting with flash configuration
Red	Booting with fixed IP address (172.23.44.111)
White	Booting with factory default settings
Cyan	Booting with customer default settings
Magenta	Booting without customer default settings

3. Hold configuration button >3 sec.

To execute the selected function, the pushbutton must be pressed and held for at least 3 seconds. The Status-LED flashes briefly and goes out to show that the switch has accepted the command. Now the pushbutton can be released, and the switch will boot to execute the command.

Note: The configuration mode is automatically exited, when the pushbutton is not pressed for more than 30 seconds.

Note: The functions four and five are only displayed if the respective configuration is stored.

Booting with Flash Configuration

By default, the switch loads all configuration parameters stored in the flash during the boot process.

In case the customer has ordered a default customized configuration, this configuration is written to the flash during production process and is available for the very first start-up.

Nexans default configuration comes with DHCP for addressing the switch. The switch sends a DHCP request as soon as the Status-LED lights up permanently on the management module. If it receives a valid response from a DHCP server, the IP parameters are accepted, and the management module can be immediately accessed via the assigned IP address. If the switch does not get a response, the DHCP request is repeated at increasing time intervals (with a maximum interval of approx. 30 seconds).

In case Nexans LANactive Manager with Zero-Touch Configuration is available in the network environment, after DHCP the switch will connect automatically to the Controller and can be configured via LANactive Manager User Interface.

If the switch has booted with a plugged-in MC card having a valid switch configuration, the 'MC' LED will light up for some seconds during booting. When the loading of the configuration of the MC card is completed, the 'MC' LED lights up permanently in green.

ANS SUPPORT PORTAL

Important notes for switches with Management Hardware HW5

Nexans strongly recommends downloading and installing the latest Switch Firmware Version. This ensures to have all the new features and bug fixes.

In addition to the new firmware, the current version of the Nexans LANactive Manager must be installed to manage switches with Management Hardware HW5. This manager version is also backward compatible with switches using Management Hardware HW3, HW2 and HW1. The current version of LANactive Manager also includes the configuration options for all new firmware features.

If you are not yet a registered user of the Nexans Support Portal, please register at the Nexans support portal <http://www.nexans-ans.de/support/> and download the latest version of the firmware and the management tool. Here you will also find the related release notes and the current versions of management manual.

If you have any questions or problems, please contact us at the following support e-mail address: support.ans@nexans.com

To benefit from individualized and extended product support, we recommend concluding a Nexans support contract.

If you are interested, please send us your request by e-mail to sales.ans@nexans.com



Please visit our support portal under:

www.nexans-ans.de/support

At our support portal, you'll find the latest information and downloads of the following points:

- Documentation
- Installation instructions
- Starter Kits
- Quick Start
- Release Notes
- Nexans LANactive Manager
- Firmware Images
- SNMP MIBs
- RMA Request
- Frequently Asked Questions (FAQs)

Nexans Advanced Networking Solutions GmbH
Support Team
Phone: +49 (0) 2166 27-2017
E-Mail: support.ans@nexans.com
Sales Team / RMA Service
Phone: +49 (0) 2166 27-2220
E-Mail: sales.ans@nexans.com

EC DECLARATION OF CONFORMITY

The manufacturer

Nexans Advanced Networking Solutions GmbH
Bonnenbroicher Strasse 2-14
41238 Moenchengladbach
Germany

declares under its sole responsibility that the products:

88306800	XGigaSwitch DICE 8TP 2SFP+ AC
88306801	XGigaSwitch DICE 8TP 2SFP+ DC
88301666	iOption PoE++ 6/8P-90W
88301604	iOption PoE+ 6/8P-30W

following the provisions of directives

2014/30/EU Electromagnetic Compatibility Directive

2014/35/EU Low Voltage Directive

2011/65/EU RoHS 2

auf die sich diese Erklärung bezieht, mit folgenden Normen übereinstimmt:
to which this declaration relates are in conformity with the following directives and standards:
qui sont l'objet de la présente déclaration répondent aux directives et normes suivantes:

EN 62368-1:2014	Audio/video, information and communication technology equipment - Part 1: Safety requirements
EN 55032:2012	Electromagnetic compatibility of multimedia equipment - Emission requirements
EN 55024:2016	Information technology equipment - Immunity characteristics - Limits and methods of measurement
EN 61000-3-2:2014	Electromagnetic compatibility (EMC) - Part 3-2: Limits - Limits for harmonic current emissions
EN 61000-3-3:2013	Electromagnetic compatibility (EMC) - Part 3-3: Limits - Limitation of voltage changes, voltage fluctuations and flicker in public low-voltage supply systems, for equipment with rated current $\leq 16A$ per phase and not subject to conditional connection
EN 50581:2012	Technical documentation for the assessment of electrical and electronic products with respect to the restriction of hazardous substances

The quality and environmental management system of Nexans Advanced Networking Solutions GmbH according to DIN EN ISO 9001:2000 and DIN EN ISO 14001:2005 ensures compliance with the European Directives and the fulfilment of the relevant standards of the European standards bodies CEN, CENELEC and ETSI.

ACCESSORIES



Power over Ethernet Options

Nexans art.-nr.	Description
88301604	PoE/PoE+ option: iOption for 6/8x ports with 30W each
88301666	PoE/PoE+/PoE++ option: iOption for 6/8x ports with 90W each



Memory Cards

Nexans Part No.	Description
88300692	SD Memory Card with MAC
88300696	SD Memory Card with MAC integrated



Nexans FTTO Power Supplies

Nexans Part No.	Description
88646283	Desktop Power Supply 54VDC/240W
88646077	Power Supply for Desk Devices 54VDC/65W



Nexans LANactive Manager

Nexans Part No.	Description
88301908	LANactive Manager Single User Licence
88301909	LANactive Manager Company Licence
88301920	LANactive Manager Controller Licence
Nexans device manager can be downloaded free of charge for evaluation purposes (max. five switches in device list and delayed starting screen) at www.nexans-ans.de/support/	



Small Form Factor Pluggable Transceiver

Nexans Part No.	Description
88646390	Nexans SFP+, 10G Base-SR, 850nm MM; 10 Gigabit Ethernet; Multimode; Tx/Rx: 850/850nm; 400m@OM4; LC-duplex; DDM Support; temp.r: -40°C/+85°C; dual fibre
88646391	Nexans SFP+, 10G Base-LR, 1310nm SM; 10 Gigabit Ethernet; Singlemode; Tx/Rx: 1310/1310nm; 10km; LC-duplex; DDM Support; temp.r: -40°C/+85°C; dual fibre
88646392	Nexans SFP+, 10G Base-BX-U, 1270nm SM Bi; 10 Gigabit Ethernet; Singlemode; Tx/Rx: 1270/1330nm; 10km; LC-simplex; DDM Support; temp.r: -40°C/+85°C; single fibre
88646393	Nexans SFP+, 10G Base-BX-D, 1330nm SM Bi; 10 Gigabit Ethernet; Singlemode; Tx/Rx: 1330/1270nm; 10km; LC-simplex; DDM Support; temp.r: -40°C/+85°C; single fibre
88646015	Nexans SFP 1000 Transceiver GI(LC)E; Gigabit Ethernet; Multimode; Tx/Rx: 850/850nm; 550 m; LC-duplex; DDM Support; temp.r: -40°C/+85°C; dual fibre
88646016	Nexans SFP 1000 Transceiver SM(LC)E L10; Gigabit Ethernet; Singlemode; Tx/Rx: 1310/1310nm; 10 km; LC-duplex; DDM Support; temp.r: -40°C/+85°C; dual fibre
88646073	Nexans SFP 1000 Transceiver SF3(LC)E L10; Gigabit Ethernet; Singlemode; Tx/Rx: 1310/1550nm; 10 km; LC-simplex; DDM Support; temp.r: -40°C/+85°C; single fibre
88646075	Nexans SFP 1000 Transceiver SF5(LC)E L10; Gigabit Ethernet; Singlemode; Tx/Rx: 1550/1310nm; 10 km; LC-simplex; DDM Support; temp.r: -40°C/+85°C; single fibre



Mounting Kits

Nexans Part No.	Description
88646400	XGigaSwitch DICE Mounting Plate
88646401	XGigaSwitch DICE Strain Relief
88646402	XGigaSwitch DICE 19" Mounting Kit
88306811	XGigaSwitch DIN-Rail Mounting Kit

Support Nexans Support-Packages

Nexans Part No.	Description
88642010	Support-Package "Engage" - Third Level Support
88642011	Support-Package "Getting Started" - Third Level Support
88643001	Enhanced Network Management Training

OFFICES

Advanced Networking Solutions

Bonnenbroicher Str. 2-14
41238 Monchengladbach
Germany
Tel: +49 2166 27-2220
Fax: +49 2166 27-2499

Nexans Cabling Solutions

Alsebergsesteenweg 2, b3
B-1501 Buizingen
Belgium
Tel: +32 (0)2 363 38 00
Fax: +32 (0)2 365 09 99