

Supporting Kits

FIBREROUTE 240mm(9.45 inch) Cabinet/Rack Mounting Kit

Nexans Ref.: N350.003SMR2

Nexans Fibre Trunking System provides a dedicated pathway for fibre optic cables and cords to protect them from accidental damage. The system offers a flexible, high-capacity solution for data centre containment which is easy to install and reconfigure to meet future needs.

DESCRIPTION

- Mounting kits available for various data centre installation environments
- Mounting on top of the Cabinet/Rack
- Adjustable according to cabinet height

Cable Tray mounting kit includes supporting bottom, screws . N350.003SMR2 is available for 240mm(9.45 inch) series. The bottom height can be adjustable from 53mm(2.1") to 200mm(7.87").

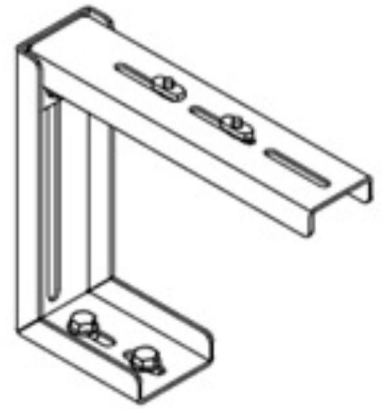

STANDARDS

International EN 50173-5; ISO/IEC 24764



Operating temp.
-25 - 60 °C



Storage temperature, range
-45 - 60 °C

All drawings, designs, specifications, plans and particulars of weights, size and dimensions contained in the technical or commercial documentation of Nexans is indicative only and shall not be binding on Nexans or be treated as constituting a representation on the part of Nexans.

Generated 12/2/21 www.nexans.no Page 1 / 2

Supporting Kits

FIBREROUTE 240mm(9.45 inch) Cabinet/Rack Mounting Kit

CHARACTERISTICS

Construction characteristics

Colour	Metalic
Material	Steel

Dimensional characteristics

Approximate net weight	1.5 kg
Approximate weight	- kg/m
Depth	- mm
Length	- mm
Width	- mm

Mechanical characteristics

Max. Load. Long Term	- N
----------------------	-----

Usage characteristics

Operating temperature, range	-25 - 60 °C
Storage temperature, range	-45 - 60 °C